

Comptrol Model DST 206
Dimensions & Load Range

PATENTED DESIGN

MAXIMUM CAPACITY: 500 lbs [2225 N]

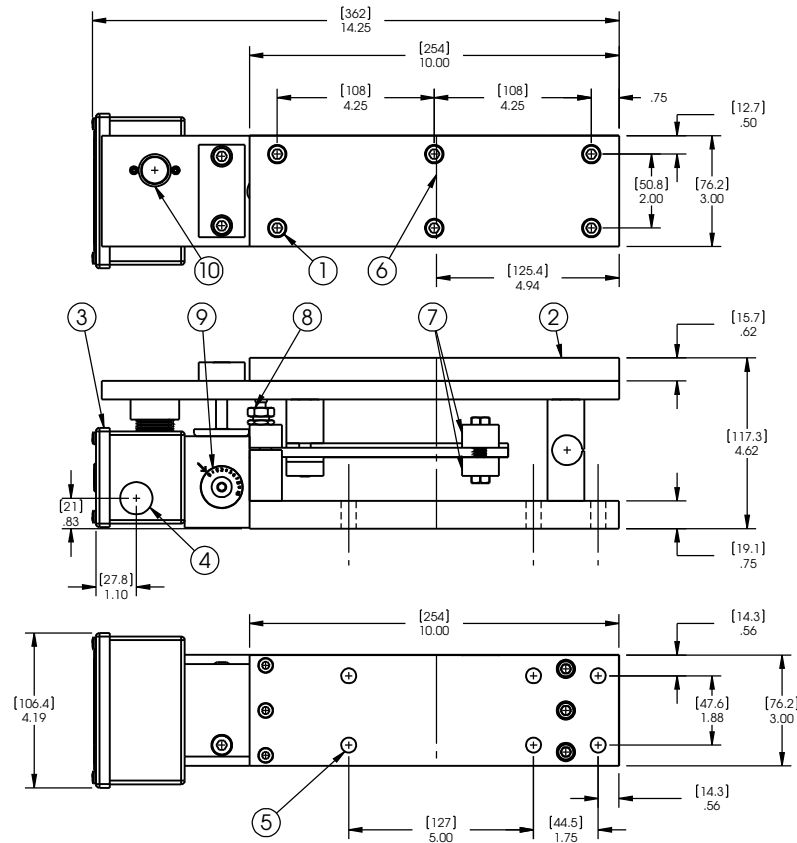

MOUNTING DETAILS

- ① 5/16-18 socket head cap screw. 1/2" diameter recessed head. Six provided for adapter plate.
- ② Removable bearing adapter plate. Maximum useable length for pillow block bearing is 10".
- ③ Conduit box cover must be accessible for electrical service.
- ④ 7/8" diameter bore for 1/2" conduit. Two provided.
- ⑤ 13/32" diameter for 3/8" mounting bolt. Six required.

OPERATIONAL FUNCTIONS

- ⑥ Centerline of roll bearing.
- ⑦ Adjustable metering block determines rating for 5 volt output.
- ⑧ Large, adjustable mechanical stop provides 1000% overload protection in tension or compression mode.
- ⑨ Adjustable viscous damper provides mechanical response damping.
- ⑩ Electrical zero adjustment provides zero volts with tare weight applied and no tension.

Note: All dimensions and specifications on this sheet are subject to change without notice.